

# Virginia Art Metal & Plastic Corp.

1520 JUNIPER STREET NORFOLK, VIRGINIA 23502  
PHONE (757) 855-3173 FAX (757) 855-7181

## engraving materials & supplies

ACRYLIC • ALUMINUM • ALLIGATOR CLIPS • ALUM OXIDE • BRASS • CLUTCHES • CLOISONNE EMBLEMS • CUTTERS • DESK PLATE HOLDER • DOUBLE-FACED FOAM TAPE • DOUBLE-FACED TAPE • GRAV OXIDE • LACQUER STICKS • MAGNETIC TAPE • NAILS • NAMEPLATE HOLDERS • NAMETAGS • NEOPRENE TAPE • PLAQUE & PICTURE HANGERS • PLASTIC • PLASTIC ADHESIVE • RIBBON BAR • ROSETTES • SAFETY LOCK PINS • SCREWS • SHEARS • SWIVEL CLIPS • TACKS • WALL BRACKETS & STAKES • WALNUT PLAQUES

ACRYLIC • ALUMINUM • ALLIGATOR CLIPS • ALUM OXIDE • BRASS • CLUTCHES • CLOISONNE EMBLEMS • CUTTERS • DESK PLATE HOLDER • DOUBLE-FACED FOAM TAPE • DOUBLE-FACED TAPE • GRAV OXIDE • LACQUER STICKS • MAGNETIC TAPE • NAILS • NAMEPLATE HOLDERS • NAMETAGS • NEOPRENE TAPE • PLAQUE & PICTURE HANGERS • PLASTIC • PLASTIC ADHESIVE • RIBBON BAR • ROSETTES • SAFETY LOCK PINS • SCREWS • SHEARS • SWIVEL CLIPS • TACKS • WALL BRACKETS & STAKES • WALNUT PLAQUES

ACRYLIC • ALUMINUM • ALLIGATOR CLIPS • ALUM OXIDE • BRASS • CLUTCHES • CLOISONNE EMBLEMS • CUTTERS • DESK PLATE HOLDER • DOUBLE-FACED FOAM TAPE • DOUBLE-FACED TAPE • GRAV OXIDE • LACQUER STICKS • MAGNETIC TAPE • NAILS • NAMEPLATE HOLDERS • NAMETAGS • NEOPRENE TAPE • PLAQUE & PICTURE HANGERS • PLASTIC • PLASTIC ADHESIVE • RIBBON BAR • ROSETTES • SAFETY LOCK PINS • SCREWS • SHEARS • SWIVEL CLIPS • TACKS • WALL BRACKETS & STAKES • WALNUT PLAQUES

ACRYLIC • ALUMINUM • ALLIGATOR CLIPS • ALUM OXIDE • BRASS • CLUTCHES • CLOISONNE EMBLEMS • CUTTERS • DESK PLATE HOLDER • DOUBLE-FACED FOAM TAPE • DOUBLE-FACED TAPE • GRAV OXIDE • LACQUER STICKS • MAGNETIC TAPE • NAILS • NAMEPLATE HOLDERS • NAMETAGS • NEOPRENE TAPE • PLAQUE & PICTURE HANGERS • PLASTIC • PLASTIC ADHESIVE • RIBBON BAR • ROSETTES • SAFETY LOCK PINS • SCREWS • SHEARS • SWIVEL CLIPS • TACKS • WALL BRACKETS & STAKES • WALNUT PLAQUES

# Engraving Machine Cutters

## SELECTED CUTTING WIDTH

LETTER HEIGHT																	
1/16"	3/32"	1/8"	3/16"	7/32"	1/4"	5/16"	3/8"	7/16"	1/2"	5/8"	3/4"	1"	1 1/4"	1 3/8"	1 1/2"	1 3/4"	2"
.005	.010	.015	.020	.025	.030	.040	.045	.050	.060	.075	.090	.125	.150	.171	.187	.210	.250
RECOMMENDED STROKE WIDTH																	

For single stroke characters, width of cut should be approximately 12% of letter height.  
 Example: 1/2" letter height = .500 x 12% = .060

Maximum stroke width for 1/8" diameter cutter is .125  
 Maximum stroke width for 11/64" diameter cutter is .171  
 Maximum stroke width for 1/4" diameter cutter is .250

## ENGRAVING CUTTERS

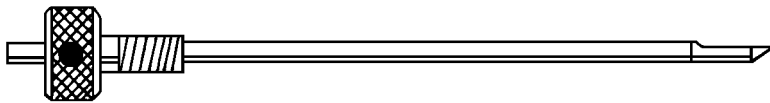

1/8" x 4 1/4"	MATERIAL TO BE ENGRAVED			
	PHENOLIC	FLEXIBLE & ACRYLIC	ALUMINUM & BRASS	STEEL & STAINLESS
HI-SPEED STEEL		CS-125-FLX	CS-125-BAL	CS-125-SSS
CARBIDE	CC-125-PHN	CC-125-FLX	CC-125-BAL	CC-125-SSS
BURNISHING			CC-125-BRN	

For use on: New Hermes models I-M, I-LL II and I-LK; Dahlgren System One and Dahlgren Wizards.

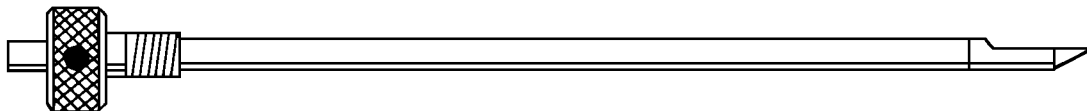

11/64" x 6"	MATERIAL TO BE ENGRAVED			
	PHENOLIC	FLEXIBLE & ACRYLIC	ALUMINUM & BRASS	STEEL & STAINLESS
HI-SPEED STEEL		CS-171-FLX	CS-171-BAL	CS-171-SSS
CARBIDE	CC-171-PHN	CC-171-FLX	CC-171-BAL	CC-171-SSS
BURNISHING			CC-171-BRN	



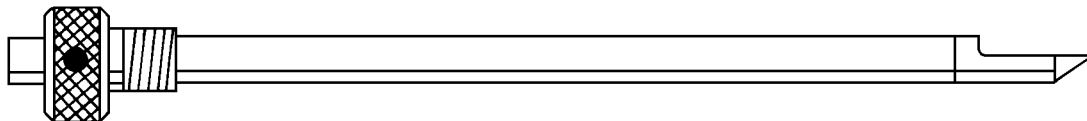





For use on: New Hermes models ITF-II, ITK-II, ITX & GTX Universal; Dahlgren System One (11/64" spindle); H-Square (11/64" spindle) & Domiteaux, New Hermes Computers

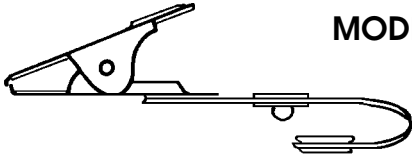

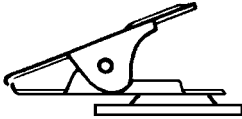
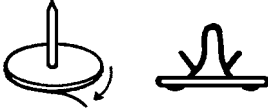
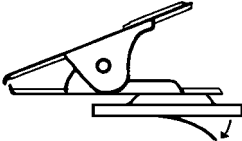



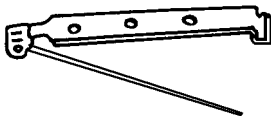

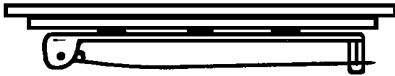
1/4" x 6"	MATERIAL TO BE ENGRAVED			
	PHENOLIC	FLEXIBLE & ACRYLIC	ALUMINUM & BRASS	STEEL & STAINLESS
HI-SPEED STEEL		CS-250-FLX	CS-250-BAL	CS-250-SSS
CARBIDE	CC-250-PHN	CC-250-FLX	CC-250-BAL	CC-250-SSS
BURNISHING			CC-250-BRN	

For use on: New Hermes models IRX-IV and IRX-KIV; Dahlgren Systems One, Two and Ten (1/4" spindle) and H-Square (1/4" spindle)

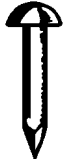

# Findings

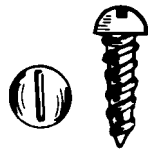
 <p>MODEL: A100S</p> <p><b>Swivel Photo ID Clip with Strap</b></p>	 <p>MODEL: A103VP Gold</p> <p><b>Tack, Vinyl Pad, 7/16" D.</b></p>
 <p>MODEL: A101VP</p> <p><b>Jumbo Swivel Clip with Vinyl Pad</b></p>	 <p>MODEL: A103PS Gold</p> <p><b>Tack, Pressure Sensitive Pad, 7/16" D.</b></p>
 <p>MODEL: A101PS</p> <p><b>Jumbo Swivel Clip with Pressure Sensitive Pad</b></p>	 <p>MODEL: A104VA SIZE: 2" MODEL: A104VB SIZE: 2-3/4"</p> <p><b>Ribbon Bar, Vinyl, Clutch Back</b></p>
 <p>MODEL: A102</p> <p><b>Alligator Clip, Plated</b></p>	 <p>MODEL: A105PA SIZE: 2" MODEL: A105PB SIZE: 2-3/4"</p> <p><b>Ribbon Bar, Pressure Sensitive, with Clutch Back</b></p>
 <p>MODEL: A102VP</p> <p><b>Swivel Alligator Clip, Plated, with Vinyl Pad</b></p>	 <p>MODEL: A106 SIZE: 1-1/2"</p> <p><b>Pinback, Plated, with Safety Clutches</b></p>
 <p>MODEL: A102PS</p> <p><b>Swivel Alligator Clip, Plated with Pressure Sensitive Pad</b></p>	 <p>MODEL: A107VP SIZE: 1-1/2"</p> <p><b>Pinback, Vinyl Pad with Safety Clutches</b></p>

# Findings & Hardware

 <p>MODEL: A108VP SIZE: 1-1/2"</p> <p><b>Pinback, Pressure Sensitive Pad with Safety Clutches</b></p>	 <p>MODEL: B201 SIZE: 5/16" FINISH: Gold or Silver</p> <p><b>Sunburst Rosettes</b></p>
 <p>MODEL: B202 SIZE: #17 x 3/8" FINISH: Brass</p> <p><b>Escutcheon Nails</b></p>	 <p>MODEL: B203 SIZE: 1/4" x 1-1/2" FINISH: Nickel</p> <p><b>Sawtooth Hanger</b></p>
 <p>MODEL: B204 SIZE: 1/4" x #2 MODEL: B205 SIZE: 3/8" x #2</p> <p><b>Screws (Finish: Gold or Silver)</b></p>	 <p>MODEL: B206 SIZE: 7/16" FINISH: Silver</p> <p><b>Plaque Screw</b></p>

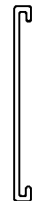
## Desk Stands & Nameplate Holders (Metal & Wood)

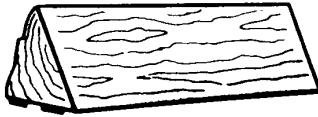
 <table data-bbox="357 1365 763 1522"> <thead> <tr> <th>MODEL</th> <th>SIZE</th> </tr> </thead> <tbody> <tr> <td>DPH208 .....</td> <td>2" x 8"</td> </tr> <tr> <td>DPH210 .....</td> <td>2" x 10"</td> </tr> <tr> <td>DPH212 .....</td> <td>2" x 12"</td> </tr> </tbody> </table> <p>Gold or Silver</p> <p><b>Traditional Desk Plate Holder</b></p>	MODEL	SIZE	DPH208 .....	2" x 8"	DPH210 .....	2" x 10"	DPH212 .....	2" x 12"	 <table data-bbox="1071 1365 1461 1564"> <thead> <tr> <th>MODEL</th> <th>SIZE</th> </tr> </thead> <tbody> <tr> <td>WH108 .....</td> <td>1" x 8"</td> </tr> <tr> <td>WH110 .....</td> <td>1" x 10"</td> </tr> <tr> <td>WH208 .....</td> <td>2" x 8"</td> </tr> <tr> <td>WH210 .....</td> <td>2" x 10"</td> </tr> <tr> <td>WH212 .....</td> <td>2" x 12"</td> </tr> </tbody> </table> <p>Gold or Silver</p> <p><b>Door or Wall Holder</b></p>	MODEL	SIZE	WH108 .....	1" x 8"	WH110 .....	1" x 10"	WH208 .....	2" x 8"	WH210 .....	2" x 10"	WH212 .....	2" x 12"
MODEL	SIZE																				
DPH208 .....	2" x 8"																				
DPH210 .....	2" x 10"																				
DPH212 .....	2" x 12"																				
MODEL	SIZE																				
WH108 .....	1" x 8"																				
WH110 .....	1" x 10"																				
WH208 .....	2" x 8"																				
WH210 .....	2" x 10"																				
WH212 .....	2" x 12"																				
 <table data-bbox="341 1722 779 1816"> <thead> <tr> <th>MODEL</th> <th>SIZE</th> </tr> </thead> <tbody> <tr> <td>PPH159 .....</td> <td>1 1/2" x 9"</td> </tr> </tbody> </table> <p>Gold or Silver</p> <p><b>Pedestal Plate Holder</b></p>	MODEL	SIZE	PPH159 .....	1 1/2" x 9"	 <table data-bbox="1169 1722 1494 1879"> <thead> <tr> <th>MODEL</th> <th>SIZE</th> </tr> </thead> <tbody> <tr> <td>DS208 .....</td> <td>2" x 8"</td> </tr> <tr> <td>DS210 .....</td> <td>2" x 10"</td> </tr> <tr> <td>DS212 .....</td> <td>2" x 12"</td> </tr> </tbody> </table> <p><b>Walnut Desk Stand</b></p>	MODEL	SIZE	DS208 .....	2" x 8"	DS210 .....	2" x 10"	DS212 .....	2" x 12"								
MODEL	SIZE																				
PPH159 .....	1 1/2" x 9"																				
MODEL	SIZE																				
DS208 .....	2" x 8"																				
DS210 .....	2" x 10"																				
DS212 .....	2" x 12"																				

# Engravers Brass

Standard Size 12" x 12"  
(can custom cut to any size)

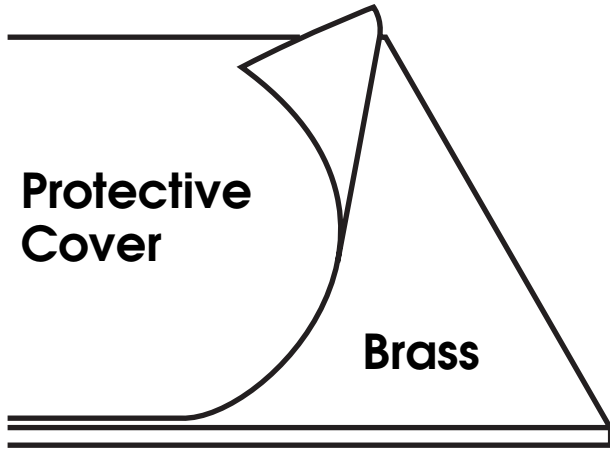

STOCK #	TYPE
FC-7020 (1/32)	Satin
FC-7050 (1/16)	Satin
HP-7020 (1/32)	High Polish
HP-7050 (1/16)	High Polish
CR-7020 (1/32)	Satin/Nickel

## Colored Brass

STOCK #	COLOR
BK-7020 (1/32)	BLACK
BL-7020 (1/32)	BLUE
BR-7020 (1/32)	BROWN
RD-7020 (1/32)	RED
GR-7020 (1/32)	GREEN

Other colors may be available upon request

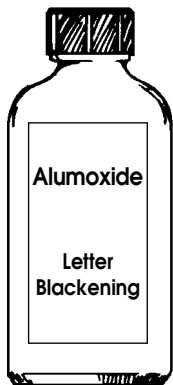



## Alumoxide & Gravoxide

For Blackening  
On Aluminum & Brass

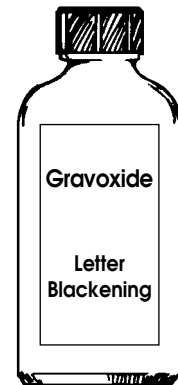
4 oz bottles

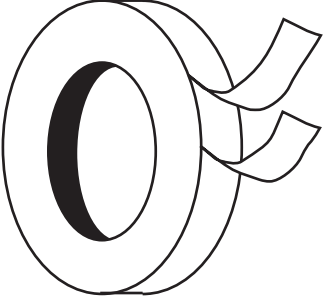
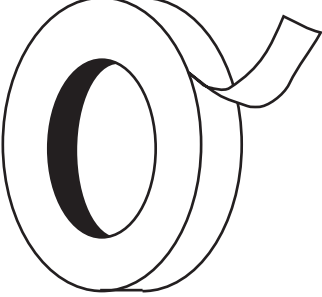
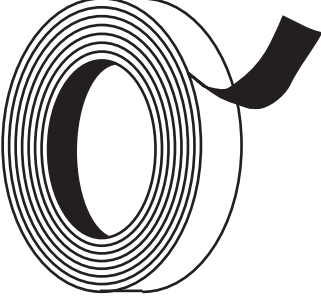
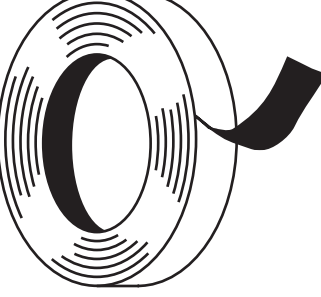

# Adhesives

 <p><b>Double Faced Tape</b> DFT50 1/2" x 36 yds DFT75 3/4" x 36 yds</p>	 <p><b>Double Faced Foam Tape</b> FT50 1/2" x 72 yds FT75 3/4" x 72 yds</p>
 <p><b>Magnetic Tape</b> MT75 3/4" x 100 ft MT100 1" x 100 ft</p>	 <p><b>Neoprene Tape</b> NT75 3/4" x 72 yds NT100 1" x 72 yds</p>
 <p><b>3M Scotch-Grip Cement</b> Bonds material together to stay. Strong and long-lasting</p>	

# Shears

## Heavy Duty Table Shear For Cutting Metals and Plastics

Ideal for cutting nameplates, badges, strips and panels. Two models available to cut metal or flexible plastic 12" to any length. Safety guard is included. Clean cut, does not burr.

Model #90M - Metals only

Model #90P - Plastic only

Spare blades also available

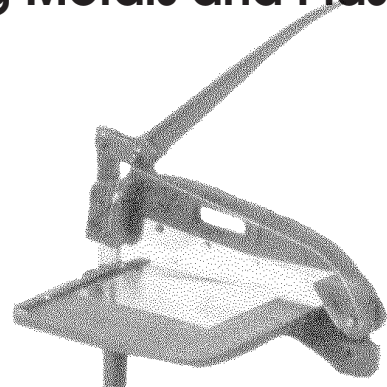

# Lacquer Sticks

Colored lacquer fill-in sticks for highlighting engraved letters or filling reverse letters in acrylic. Available 12 to a box (one color or multi) or sold individually. Colors available: Black, White, Red, Blue, Green, Orange, Yellow, Gold or Silver.



# DAMAGE CONTROL

**All aluminum damage control plates meet the following Military Specifications;**

MIL-P-514(docks) para. 3.2.5 Composition C shall be photosensitive aluminum in accordance with GG-P-455.

MIL-P-15024D Type H. Type H plates shall be aluminum alloy with a totally anodized surface. characters shall be integrated into the anodized layer by a photographic process using silver compounds.

MIL-P-19834-B Amendment 3, Type I and Type II. Parts produced from Metalphoto with the proper adhesive affixed exceed the performance requirements as listed in paragraph 3.4.

GG-P-455b Federal Specification Plates and Foils, Photographic (Photosensitive Anodized aluminum) Type 1. Impregnated with silver compounds (Grade A).

**All stainless steel (CRES), damage control plates meet the following Military Specifications;**

MIL-P-15024D Type A. Etched or chemicallyt engraved

QQ-S-766 Steel Plate, Sheet, and Strip-Corrosion Resisting.

**All stainless steel (CRES), brass and plastic damage control plates meet the following Military Specifications;**

MIL-P-15024D Type B. Engraved.

## Classification Plates

X, Y, W, Circle W Circle X

2, 3 And 4 Inches

Z, Circle Z, Z Black Dog

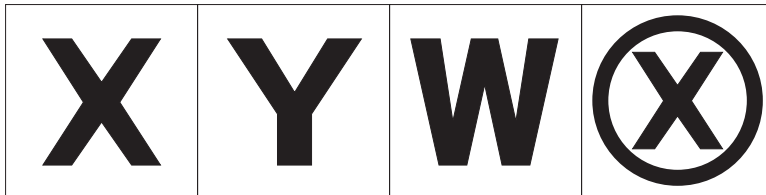

## Damage Control Plates and Shipboard Identification

Our label plate specialists are fully trained in all aspects of shipboard identification. From updated Compartment Check Off Lists & Damage Control Manuals. Our factory trained labeling specialist are ready to help you on any job that is to large or that you can't handle with the equipment you have at hand.